

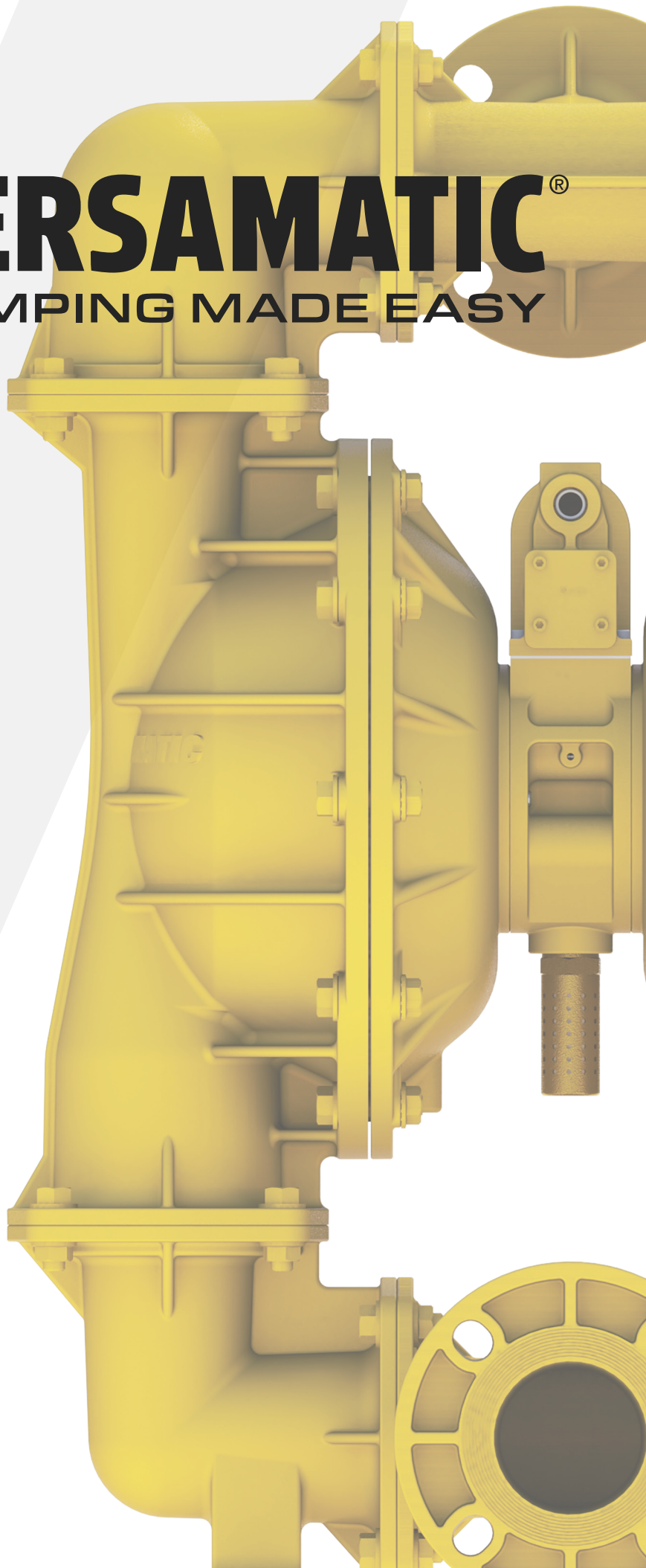

# VERSAMATIC<sup>®</sup>

PUMPING MADE EASY



SCAN TO SEE OUR PUMP SELECTOR TOOL



AIR OPERATED DOUBLE DIAPHRAGM PUMPS

# WHY VERSAMATIC?

Since 1983, Versamatic has provided reliable, quality AODD pumping solutions globally to customer who value simplicity, quick delivery and convenience.

When purchasing Versamatic products, you can be confident knowing you are fully supported by experienced teams of professionals from product selection to installation and beyond.



## AWARD-WINNING MANUFACTURING FACILITY

80,000 square foot manufacturing plant. Award-winning facility, ensuring continuous improvement.

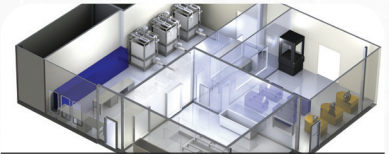

## NEWLY EXPANDED, STATE OF THE ART TEST LAB

Increased test capacity, performance, and endurance. Improved overall efficiency.



## PRODUCT ENDURANCE LAB

Ensures product performance and drives product enhancements.



## APPLICATIONS ENGINEERING, CUSTOMER SERVICE & AFTER SALES SUPPORT

From product selection, to troubleshooting, our team of experts are ready to help.



## 100% TESTED QUALITY ASSURANCE

Enables consistent quality through scientific processes.



## GENUINE KITS AND PARTS

Provide guaranteed quality and ease of maintenance.



## DEDICATED TEAM TO SUPPORT YOU!

Providing product expertise, personalized service, and after sales support.

# THE VERSAMATIC ADVANTAGE

We make pumping easy with our complete line of bolted metal, bolted plastic and clamped metal AODD pumps offered in a wide range of sizes and flow rates. We've set the standard of performance in AODD pumps, and are committed to providing quality AODD pumps for customers who value reliability, quick delivery and convenience.

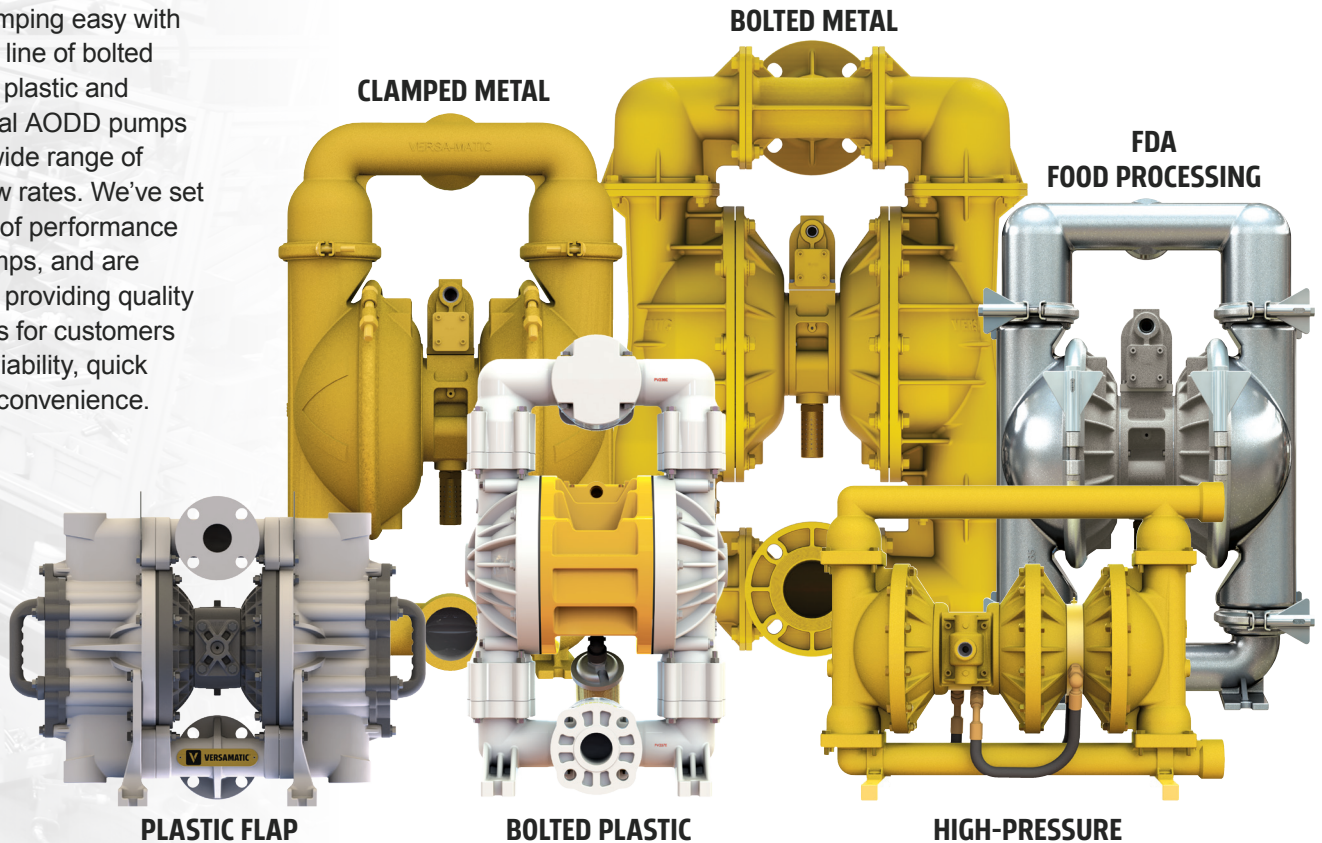

**EXTENSIVE GLOBAL DISTRIBUTION NETWORK**



**QUICK SHIP PROGRAM**

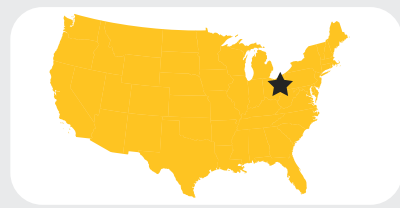

**DESIGNED AND ASSEMBLED IN THE USA**



**PRODUCT ASSURANCE**



**PRODUCT TESTING**

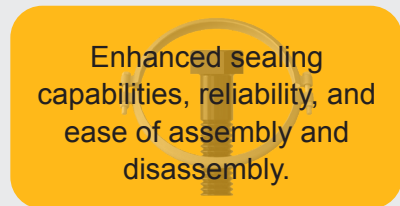

**CLAMPED OR BOLTED CONSTRUCTION**

# VALOR

## PUMPING HAS NEVER BEEN EASIER

Effortless to maintain. Flexible by design. Built robustly for reliable performance. Versamatic's Valor AODD pump, patent pending.

This new 1" pump with an innovative center section makes conquering pumping challenges easier than ever. Ideal for pump users across a multitude of markets and applications. Expect additional pump sizes to build out the Valor series with the same innovative features. Watch the video to see how.

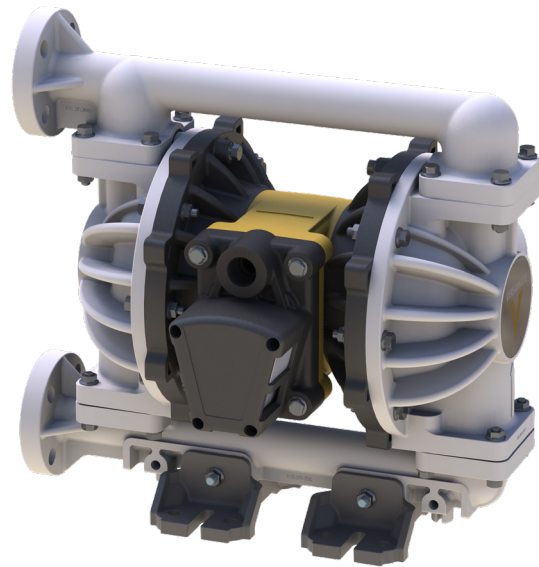

## PERFORMANCE

### Flow Rate

Adjustable to . . . . 0-63 gpm (238 lpm)

### Port Size - Suction / Discharge

. . . . . 1" ANSI/DIN Flange

### Max Solid Size (Diameter)

. . . . . 0.25" (6 mm)

**Air Inlet** . . . . . 3/4" NPT

**Air Exhaust** . . . . . 1" NPT

**Suction Lift** . . . . . 19' (5.8 m) Dry

. . . . . 31' (9.5 m) Wet

### Weights

. . . . . Polypropylene 25 lbs. (11.3 kg)

. . . . . PVDF 42 lbs. (19 kg)

Conductive Poly (ATEX) 28lbs (12.7 kg)

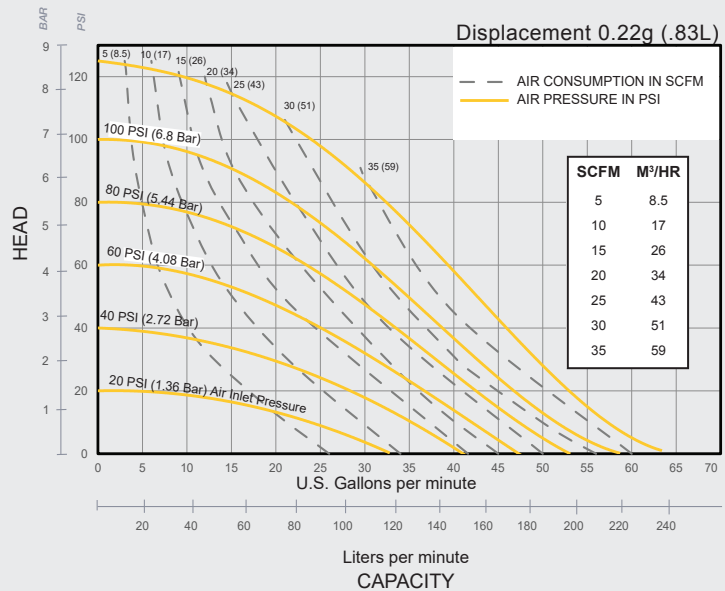

**Class Leading Flow Rates** – 63 GPM (238 lpm)

**Plastic corrosion resistant** Wet Side and Air Side

**Low weight for ease of mobility** (25lbs for Polypropylene model)

**Bolted Construction** capable of 125 psi (8.6 Bar)

**New Nomenclature:** VALOR 1" models begin with "VMV10B"



# ROCKSTAR

## SOLIDS HANDLING SOLUTION

The 2" (51 mm) plastic Flap Valve Pump was designed to offer superior solids handling in a chemically resistant light weight portable design. These attributes make it perfect for chemical sump, utility and mine de-watering applications.

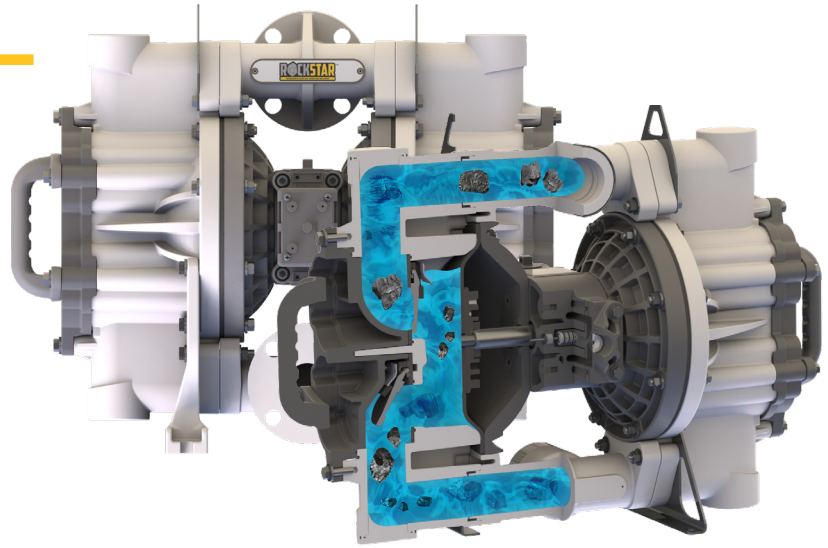

## PERFORMANCE

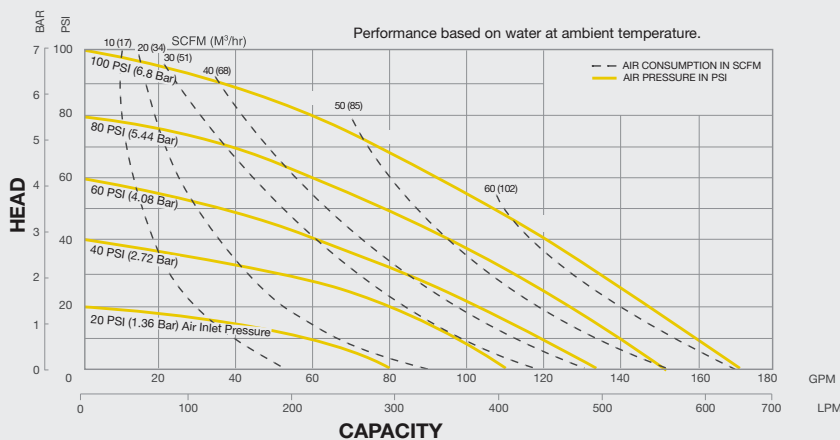

### SOLIDS HANDLING RANGE

Up to 8" (46mm)

### LIGHTWEIGHT & PORTABLE

At 59 lbs (26.8 kg) it is safely and easily transported

### TOP SUCTION / BOTTOM DISCHARGE

Gravity assist is ideal for pumping liquids with settling solids

### BEST-IN-CLASS FLOW RATE

170 GPM (644 lpm)

### ALL BOLTED CONSTRUCTION

Rugged, leak free design

### SUPERIOR DRY PRIME

Up to 19' (5.8m) of water

## EASE OF MAINTENANCE

Quick Access to Serviceable Components

### REMOVE CLEAN-OUT CAP

By simply removing six bolts securing the clean-out cap in place, it allows access to clear simple clogs without disassembling the entire pump.

### MODULAR CHECK VALVE ACCESS

With the clean-out cap removed, the flap valves can be inspected and / or replaced as needed; four bolts hold the modular flap valves in place for quick maintenance and repair.

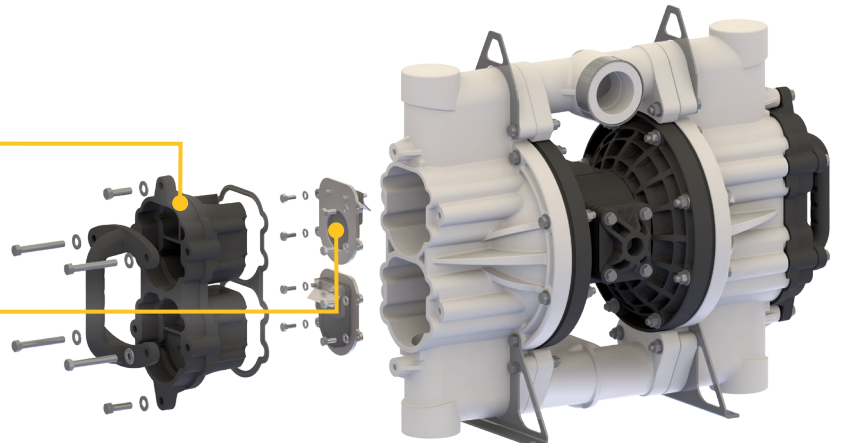

# RELIABLE PUMPING MADE EASY

Proudly assembled in Mansfield, Ohio you count on the consistency, reliability and trouble-free operation of Versamatic's air-operated double-diaphragm (AODD) pumps to keep your process running.



## RELIABLE PERFORMANCE

Versamatic pumps are designed to reduce downtime, which leads to **more effective and efficient processes.**



## SIMPLE CONSTRUCTION

An AODD pump's simple design and easy-to-understand principles **keep your processes working at top speed.**



## APPLICATION VERSATILITY

Your pump should be able to **effectively handle a broad array of fluid types**, from water to products that are viscous or abrasive.



## GLOBAL DISTRIBUTION

Get **expert solutions, convenience, local service and support** no matter where you're located in the world.



## COMPLETE PRODUCT OFFERING

Our diverse portfolio of AODD pumps gives you the **versatility and flexibility you need to make pumping easy.**

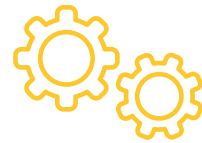

## WORLD-CLASS MANUFACTURING & SUPPORT

When you partner with Versamatic you can expect **short lead times and on-time delivery.** We have the part you need - when you need it - in stock.

## SUPPORT MADE EASY

Visit us online to quickly access useful resources.



BLOGS



PUMP SELECTOR



LITERATURE



CHEM GUIDE









VIDEOS



ALL RESOURCES

# WHY AODD PUMPS?

							
<b>PUMP TYPE:</b>	AODD	Centrifugal	Lobe	Gear	Progressive (screw)	Peristaltic (hose)	Piston/Plunger
<b>TECHNOLOGY:</b>	Non PD Reciprocating	Kinetic	PD Rotary	PD Rotary	PD Rotary	PD Rotary	PD Reciprocating
<b>Variable Flow &amp; Head Control:</b> (inherently adjustable)	✓	!	!	!	!	!	!
<b>Deadheads Safely:</b> (at zero energy consumption)	✓	!	!	!	!	!	!
<b>Dry-Running:</b>	✓	✗	✗	✗	✗	✗	✗
<b>Dry-Priming:</b> (lift installations)	✓	✗	✗	✗	✗	✗	!
<b>No Installation Alignment Required:</b>	✓	✗	✗	✗	✗	✗	✗
<b>No Electrical Installation Required:</b>	✓	✗	✗	✗	✗	✗	✗
<b>Portability:</b>	✓	!	!	!	!	!	!
<b>Submersible:</b>	✓	!	✗	✗	✗	✗	✗
<b>Sealless:</b> (no packing or mechanical seals)	✓	!	!	!	!	!	!
<b>No Slip:</b> (thin liquids)	✓	!	!	!	!	!	!
<b>Cavitation Tolerance:</b> (low NPSHa)	✓	✗	!	!	!	!	!
<b>Low Shear &amp; Degradation:</b>	✓	✗	!	!	!	!	!

✓ = Best Fit    ! = Limitations    ✗ = Not Recommended

- Run-dry without damaging the pump or system
- Pump solid laden fluids without pump or product damage
- Self-priming, works in suction lift applications
- Deadheads safely, with no pump or product damage
- Shear sensitive, does not shear or separate product being pumped
- No electricity required, and can be fully grounded
- Low initial purchase price compared to other technologies
- Submersible, can be submerged completely without safety or performance issues
- Sealless design, no expensive mechanical seals or packing are required
- Variable flow and head pressures, without sophisticated controls

# INSTALLATION VERSATILITY

All installations: Run-dry capable • No heat generation • No electricity required

## SUCTION LIFT

- Self-priming
- High vacuum capable
- Max lift of 32' (9.8m)

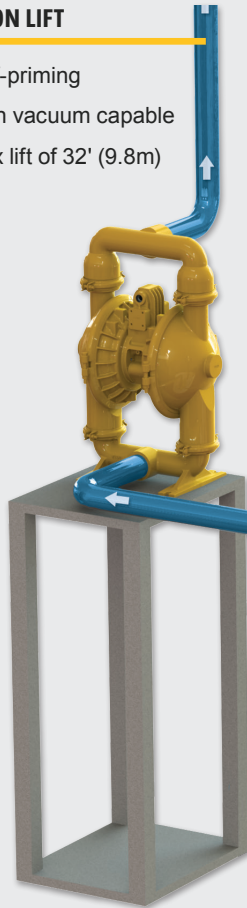

## SUBMERGED

- Capable of full submersion
- Screened inlet option



## FLOODED SUCTION

- Preferred for viscous fluids
- Most common application
- Screened inlet option



**NOTE:** Consult your distributor or owners manual for proper materials of construction and installation for your application.

## MARKETS WE SERVE



# MATERIALS

MATERIAL PROFILE	OPERATING TEMP	
	MAX.	MIN.
<b>Conductive Acetal:</b> Tough, impact resistant, ductile. Good abrasion resistance and low friction surface. Generally inert, good chemical resistance except for strong acids and oxidizing agents.	190°F 88°C	-20°F -29°C
<b>EPDM:</b> Very good water and chemical resistance. Has poor resistance to oils and solvents, but is fair in ketones and alcohols.	280°F 138°C	-40°F -40°C
<b>FKM:</b> (Fluoroelastomers) Shows good resistance to a wide range of oils and solvents; especially all aliphatic, aromatic and halogenated hydrocarbons, acids, animal and vegetable oils. Hot water or hot aqueous solutions (over 70°F) will attack FKM.	350°F 177°C	-40°F -40°C
<b>Hytrel®:</b> Good on acids, bases, amines and glycols at room temperatures only.	220°F 104°C	-20°F -29°C
<b>Neoprene:</b> All purpose. Resistance to vegetable oils. Generally not affected by moderate chemicals, fats, greases and many oils and solvents. Generally attacked by strong oxidizing acids, ketones, esters and nitro hydrocarbons and chlorinated aromatic hydrocarbons.	200°F 93°C	-10°F -23°C
<b>Nitrile:</b> General purpose, oil-resistant. Shows good solvent, oil, water and hydraulic fluid resistance. Should not be used with highly polar solvents like acetone and MEK, ozone, chlorinated hydrocarbons and nitro hydrocarbons.	190°F 88°C	-10°F -23°C
<b>Polypropylene:</b> A thermoplastic polymer. Moderate tensile and flex strength. Resists strong acids and alkali. Attacked by chlorine, fuming nitric acid and other strong oxidizing agents.	180°F 82°C	32°F 0°C

MATERIAL PROFILE	OPERATING TEMP	
	MAX.	MIN.
<b>PVDF:</b> (Polyvinylidene Fluoride) A durable fluoroplastic with excellent chemical resistance. Excellent for UV applications. High tensile strength and impact resistance.	250°F 121°C	0°F -18°C
<b>Santoprene®:</b> Injection molded thermoplastic elastomer with no fabric layer. Long mechanical flex life. Excellent abrasion resistance.	275°F 135°C	-40°F -40°C
<b>UHMW PE:</b> A thermoplastic that is highly resistant to a broad range of chemicals. Exhibits outstanding abrasion and impact resistance, along with environmental stress-cracking resistance.	180°F 82°C	-35°F -37°C
<b>Urethane:</b> Shows good resistance to abrasives. Has poor resistance to most solvents and oils.	150°F 66°C	32°F 0°C
<b>Virgin PTFE:</b> (PFA/TFE) Chemically inert, virtually impervious. Very few chemicals are known to chemically react with PTFE; molten alkali metals, turbulent liquid or gaseous fluorine and a few fluoro-chemicals such as chlorine trifluoride or oxygen difluoride which readily liberate free fluorine at elevated temp.	220°F 104°C	-35°F -37°C

*Maximum and Minimum Temperatures are the limits for which these materials can be operated. Temperatures coupled with pressure affect the longevity of diaphragm pump components. Maximum life should not be expected at the extreme limits of the temperature ranges.*

### METALS

**Stainless Steel:** Equal to or exceeding ASTM specification A743 CF-8M for corrosion resistant iron chromium, iron chromium nickel and nickel based alloy castings for general applications. Commonly referred to as 316 Stainless Steel in the pump industry.

# HOW TO READ A PERFORMANCE CURVE

## 1. SELECT FLOW RATE (GPM)

Example: **80** GPM

## 2. DETERMINE DISCHARGE HEAD (PSI)

Example: **60** PSI

## 3. SEE INLET AIR PRESSURE (PSI)

Example: **100** PSI

## 4. SEE AIR CONSUMPTION (SCFM)

Example: **80** SCFM

### SELECTION TIP: SIZE-UP

Size-up your pump to increase energy savings and reduce wear on pump to measurably reduce total cost of ownership.

Contact your distributor or Versamatic application engineer for more information: [apptech.warrenrupp@idexcorp.com](mailto:apptech.warrenrupp@idexcorp.com)

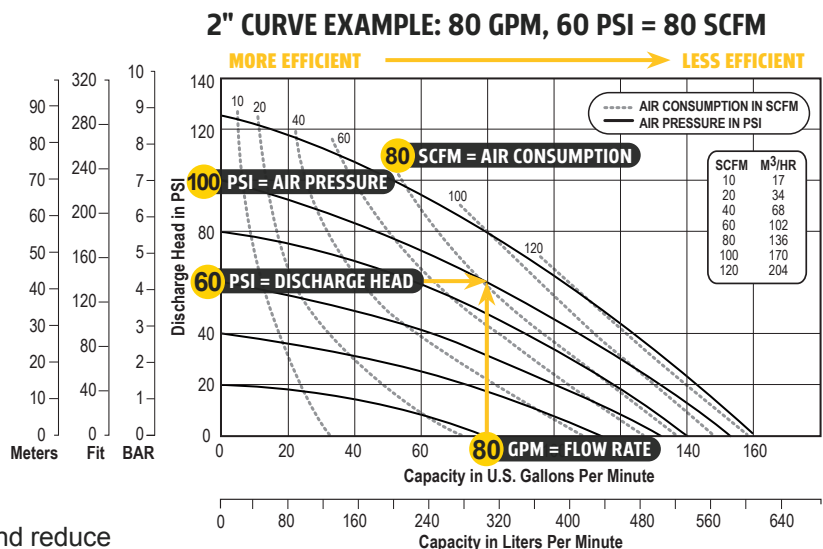

# PUMP MODEL CODES

## HOW TO READ VERSAMATIC MODEL CODES

1 2 3 4 5 6 7 8 9 10 - A A A

### MODEL

E Elima-Matic®  
U Ultra-Matic®

1

### PUMP SIZE

6 1/4" (6mm)  
8 3/8" (8mm)  
5 1/2" (13mm)  
7 3/4" (19mm)  
1 1" (25mm)  
4 1-1/4" or 1-1/2" (38mm)  
40 1-1/2" (38mm)  
2 2" (51mm)  
3 3" (76mm)

2

### WETTED (NON-ELASTOMERIC)

A Aluminum  
C Cast Iron  
S Stainless Steel  
P Polypropylene  
K PVDF

3

OUTER CHAMBER

INNER CHAMBER

### NON-WETTED

A Aluminum  
S Stainless Steel  
P Polypropylene  
J Nickel-Plated Aluminum

4

DIAPHRAGM

### DIAPHRAGM

1 Neoprene  
2 Nitrile (Buna)  
3 FKM (Fluoroelastomers)  
4 Nordel® (EPDM)  
5 PTFE  
6 TPE-XL (Santoprene®)  
7 Hytre®  
Y FDA TPE-XL (Santoprene®)

5

SUCTION

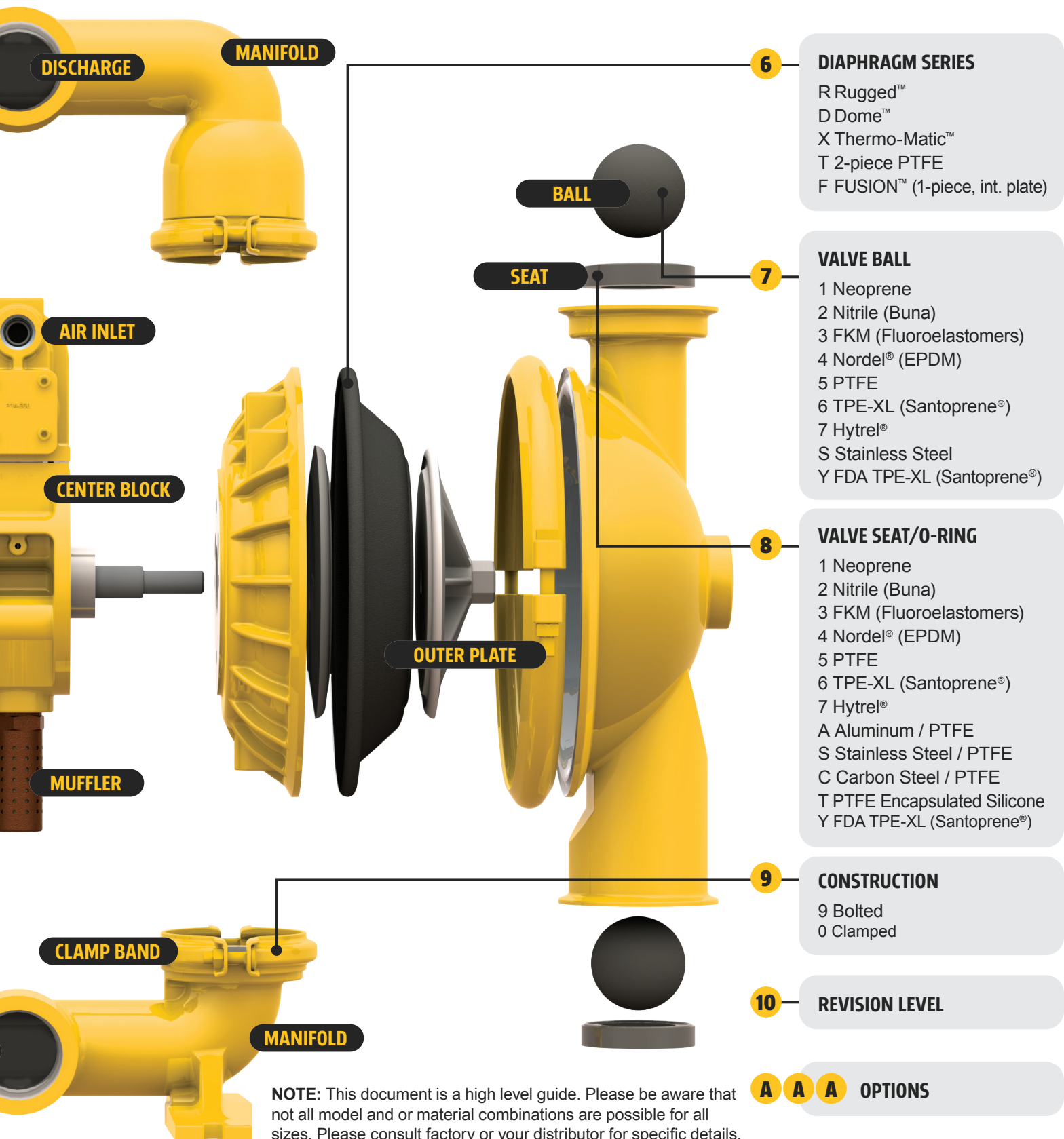

# BOLTED METAL

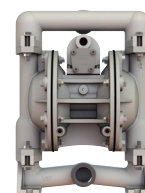
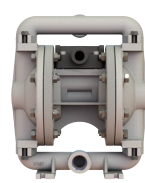
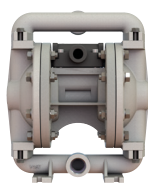

	<b>1/2" (12.7 MM)</b>	<b>3/4" (19 MM)</b>	<b>1" (25.4 MM)</b>
<b>PORT SIZE</b>	<b>1/2" (12.7 MM)</b>	<b>3/4" (19 MM)</b>	<b>1" (25.4 MM)</b>
<b>Pump Model</b>	E5	E7	E1
<b>Wetted Material Option</b>	AL / SS	AL	AL / SS
<b>Air Side material</b>	AL / PP	AL / PP	AL / PP / AL-NP
<b>Max Flow Rate Per Minute</b>	12 gpm (45.4 lpm)	12 gpm (45.4 lpm)	49 gpm (181.7 lpm)
<b>Porting Configurations</b>	Suction: Center Horz. Discharge: Center Horz.	Suction: Center Horz. Discharge: Center Horz.	Suction: Center Horz. Discharge: Center Horz.
<b>Connection Type</b>	1/2" NPT	3/4" NPT	1" NPT or BSP
<b>Maximum Dry Suction Lift</b>	13' (3.9 m)	13' (3.9 m)	15' (4.6 m)
<b>Air Inlet: Port Air Exhaust: Port</b>	Inlet: 3/8" NPT Exhaust: 3/8" NPT	Inlet: 3/8" NPT Exhaust: 3/8" NPT	Inlet: 3/8" NPT Exhaust: 1/2" NPT
<b>Max Solids Handling</b>	0.063" (1.6 mm)	0.063" (1.6 mm)	0.125" (3.2mm)
<b>Max. Displacement per stroke</b>	0.022 gal (0.08 L)	0.022 gal (0.08 L)	0.1 gal (0.38 L)
<b>Maximum Air Inlet Pressure</b>	125 psi (8.6 bar)	125 psi (8.6 bar)	125 psi (8.6 bar)
<b>Shipping weight</b>	11-17 lbs (3.9-7.7 kg)	11-17 lbs (3.9-7.7 kg)	27-40 lbs (12.2-18.1 kg)
<b>Height</b>	10.05" (255.3 mm)	10.05" (255.3 mm)	14.54" (369.3 mm)
<b>Width</b>	8.39" (213.1 mm)	8.39" (213.1 mm)	10.75" (273.5 mm)
<b>Depth</b>	6.25" (158.8 mm)	6.25" (158.8 mm)	9.33" (237 mm)
<b>Base to Suction</b>	0.95" (24.1 mm)	0.95" (24.1 mm)	1.56" (38.6 mm)
<b>Base to Discharge</b>	9.35" (237.5 mm)	9.35" (237.5 mm)	13.73" (348.7 mm)

SPECIFICATIONS

AL-Aluminum, SS-Stainless Steel, AL-NP-Nickle Plated Aluminum

PP-Polypropylene

See service manual for complete specifications

\*Standard Configuration



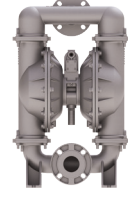
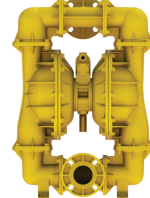
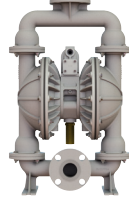
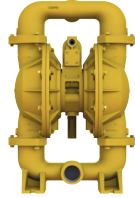
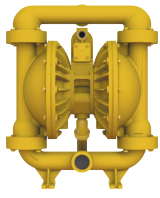

1.5" (38 MM)	2" (50.8 MM)	2" (50.8 MM)	3" (76.2 MM)	3" (76.2 MM)
E40	E2	E2	E3	E3
AL / SS	AL	SS	AL	SS
AL / SS / AL-NP	AL	AL / SS	AL	AL / SS
123 gpm (465 lpm)	163 gpm (617 lpm)	160 gpm (606 lpm)	273 gpm (1033 lpm)	273 gpm (1033 lpm)
Suction: Center Horz. Discharge: Center Horz.	Suction: Center Horz. Discharge: Center Horz.	Suction: Center Horz Discharge: Center Horz or Vert	Suction: Center Horizontal* Discharge: Center Horizontal*	Suction: Center Horizontal Discharge: Center Horizontal
1.5" NPT or BSP	2" NPT or BSP	2" ANSI / DIN 2" NPT / BSP"	3" ANIS / DIN 3" NPT / BSP	3" ANIS / DIN 3" NPT / BSP
19' (5.8 m)	18' (5.5 m)	14' (4.3 m)	16' (4.9 m)	16' (4.9 m)
Inlet: 1/2" NPT (3/4" NPT, SS) Exhaust: 1" NPT	Inlet: 1/2" NPT Exhaust: 1" NPT	Inlet: 1/2" NPT (3/4" NPT, SS) Exhaust: 1" NPT	Inlet: 1/2" NPT Exhaust: 1" NPT	Inlet: 1/2" NPT (3/4" NPT, SS) Exhaust: 1" NPT
0.25" (6.3 mm)	0.43" (11.1 mm)	0.25" (6.3 mm)	0.375" (9.5 mm)	0.500 (12.7 mm)
0.44 gal (1.67 L)	0.60 gal (2.27 L)	0.49 gal (1.85 L)	1.46 gal (5.5 L)	1.46 gal (5.5 L)
125 psi (8.6 bar)	125 psi (8.6 bar)	125 psi (8.6 bar)	125 psi (8.6 bar)	125 psi (8.6 bar)
55-92 lbs (25-41.7 kg)	81 lbs (36.7 kg)	114 lbs (51.7 kg)	146 lbs (66.2 kg)	245 lbs (111.1 kg)
22.2" (563.9 mm)	26.66" (677.1 mm)	27.77" (705.4 mm)	36.31" (922.3 mm)	36.26" (919.2 mm)
18.55" (471.2 mm)	17.72" (450.1 mm)	17.72" (450.1 mm)	25.12" (638.1 mm)	22.06" (560.3 mm)
12.22" (310.4 mm)	13.13" (333.5 mm)	12.03" (305.6 mm)	16.11" (409.2 mm)	16.08" (408.4 mm)
3.13" (79.5mm)	2.52" (64.0 mm)	3.39" (86.1 mm)	4.38" (111.3 mm)	4.44" (112.8 mm)
20.9" (530.9 mm)	24.88" (363.0 mm)	27.77" (705.4 mm)	32.38" (822.5 mm)	32.32" (820.9 mm)

# CLAMPED METAL

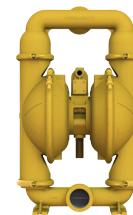
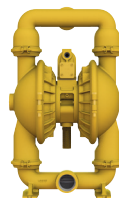
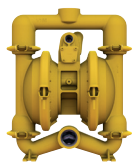

	1.5" (38 MM)	2" (50.8 MM)	3" (76.2 MM)
<b>PORT SIZE</b>	<b>1.5" (38 MM)</b>	<b>2" (50.8 MM)</b>	<b>3" (76.2 MM)</b>
<b>Pump Model</b>	E4	E2	E3
<b>Wetted Material Option</b>	AL / CI / SS	AL / CI / SS	AL / CI / SS
<b>Air Side Material</b>	AI / AL-NP	AI / SS / AL-NP	AI / SS / AL-NP
<b>Max Flow Rate Per Minute</b>	71 gpm (268 lpm)	185 gpm (700 lpm)	234 gpm (886 lpm)
<b>Porting Configurations</b>	Suction: Center Horz Discharge: Center Vert	Suction: Center Horz Discharge: Center Vert	Suction: Center Horz Discharge: Center Vert
<b>Connection Type</b>	Suction: 1 1/2" NPT or BSP Discharge: 1 1/4" NPT or BSP	Suction: 2" NPT or BSP Discharge: 2" NPT or BSP	Suction: 3" NPT or BSP Discharge: 3" NPT or BSP
<b>Maximum Dry Suction Lift</b>	19' (5.8 m)	17' (5.2 m)	20' (6.1 m)
<b>Air Inlet: Port Air Exhaust: Port</b>	Inlet: 1/2" NPT Exhaust: 3/4" NPT	Inlet: 1/2" NPT (3/4" NPT, SS) Exhaust: 1" NPT	Inlet: 1/2" NPT (3/4" NPT, SS) Exhaust: 1" NPT
<b>Max Solids Handling</b>	0.188" (4.8 mm)	0.25" (6.4 mm)	.375" (9.5 mm)
<b>Max. Displacement Per Stroke</b>	.25 gal (0.95 L)	0.60 gal (2.3 L)	1.36 gal (5.1 L)
<b>Maximum Air Inlet Pressure</b>	125 psi (8.6 bar)	125 psi (8.6 bar)	125 psi (8.6 bar)
<b>Shipping Weight</b>	55-95 lbs (25-43 kg)	65-144 lbs (29.5-65.3 kg)	108-233 lbs (49.0-105.7 kg)
<b>Height</b>	AL: 17.11" (434.6 mm) CI: 16.88" (428.6 mm) SS: 16.7" (425.8 mm)	AL: 26.69" (678.0 mm) CI: 26.19" (665.2 mm) SS: 26.22" (666.0 mm)	AL: 32.09" (815.1 mm) CI: 32.78" (832.5 mm) SS: 32.01" (813.1 mm)
<b>Width</b>	AL: 14.17" (360.0 mm) CI: 14.36" (364.7 mm) SS: 14.40" (365.7 mm)	AL: 16.38" (416.1 mm) CI: 16.38" (416.1 mm) SS: 15.87" (403.1 mm)	20.01" (508.2 mm)
<b>Depth</b>	11.50" (292.1 mm)	13.59" (345.2 mm)	15.01" (381.1 mm)
<b>Base to Suction</b>	AL: 2.55" (64.77 mm) CI: 2.63" (66.7 mm) SS: 2.55" (64.77 mm)	AL: 2.03" (51.6 mm) CI: 2.53" (64.3 mm) SS: 1.72" (43.7 mm)	AL: 2.25" (57.2 mm) CI: 2.49" (63.3 mm) SS: 2.31" (58.7 mm)
<b>Base to Discharge</b>	AL: 17.11" (434.6 mm) CI: 16.88" (428.6 mm) SS: 16.76" (425.8 mm)	AL: 25.05" (636.3 mm) CI: 24.55" (623.6 mm) SS: 24.72" (627.9 mm)	AL: 29.90" (759.4 mm) CI: 30.43" (772.9 mm) SS: 29.76" (755.9 mm)

SPECIFICATIONS

AL-Aluminum, CI-Cast Iron, SS-Stainless Steel, AL-NP-Nickle Plated Aluminum

See service manual for complete specifications

\*Standard Configuration



# FDA / HYGIENIC

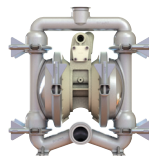



	<b>1/2" (12.7 MM)</b>	<b>1" (25.4 MM)</b>	<b>1.5" (38 MM)</b>	<b>2" (50.8 MM)</b>	<b>3" (76.2 MM)</b>
<b>PORT SIZE</b>	<b>1/2" (12.7 MM)</b>	<b>1" (25.4 MM)</b>	<b>1.5" (38 MM)</b>	<b>2" (50.8 MM)</b>	<b>3" (76.2 MM)</b>
<b>Pump Model</b>	E5	E1	E4	E2	E3
<b>Wetted Material Options</b>	316 SS	316 SS	316 SS	316 SS	316 SS
<b>Air Side Material</b>	PP	PP / AL-NP	AL-NP	SS / AL-NP	SS / AL-NP
<b>Max Flow Rate Per Minute</b>	12 gpm (45.4 lpm)	46 gpm (174.1 lpm)	70 gpm (265 lpm)	185 gpm (700 lpm)	234 gpm (886 lpm)
<b>Porting Configurations</b>	Suction: Center Horz Discharge: Center Horz	Suction: Center Horz Discharge: Center Horz	Suction: Center Horz Discharge: Center Horz	Suction: Center Horz Discharge: Center Horz	Suction: Center Horz Discharge: Center Horz
<b>Connection Type</b>	1 1/2" Tri-Clamp	1 1/2" Tri-Clamp	2" Tri-Clamp	2 1/2" Tri-Clamp	3" Tri-Clamp
<b>Maximum Viscosity, cSt / SSU</b>	cSt - 2,000 SSU -9,400	cSt - 2,000 SSU -9,401	cSt - 90,000 SSU - 415,500	cSt - 90,000 SSU - 415,501	cSt - 90,000 SSU - 415,502
<b>Maximum Dry Suction Lift</b>	13' (3.9 m)	16' (4.9 m)	15' (4.6 m)	17' (5.1 m)	20' (6.1 m)
<b>Air Inlet: Port Air Exhaust: Port</b>	Inlet: 3/8" NPT Exhaust: 3/8" NPT	Inlet: 3/8" NPT Exhaust: 1/2" NPT	Inlet: 1/2" NPT Exhaust: 3/4" NPT	Inlet: 1/2" NPT (3/4" NPT, SS) Exhaust: 1" NPT	Inlet: 1/2" NPT (3/4" NPT, SS) Exhaust: 1" NPT
<b>Max Solids Handling</b>	0.063" (1.6 mm)	0.125" (3.2mm)	0.18" (4.76 mm)	0.25" (6.3 mm)	0.375" (9.5 mm)
<b>Max. Displacement Per Stroke</b>	0.022 gal (0.08 L)	0.09 gal (0.34 L)	0.25 gal (0.95 L)	0.60 gal (2.27 L)	1.36 gal (5.1 L)
<b>Maximum Air Inlet Pressure</b>	100 psi (6.8 bar)	100 psi (6.8 bar)	125 psi (8.6 bar)	125 psi (8.6 bar)	125 psi (8.6 bar)
<b>Cleaning / Sanitizing Method</b>	Clean Out of Place (COP)	Clean Out of Place (COP)	Clean Out of Place (COP)	Clean Out of Place (COP)	Clean Out of Place (COP)
<b>Wetted Casting Surface Finish, Microinches (Micrometers)</b>	Ra 125 μ-in (3.175 μ-m)	Ra 125 μ-in (3.175 μ-m)	Ra 125 μ-in (3.175 μ-m)	Ra 125 μ-in (3.175 μ-m)	Ra 125 μ-in (3.175 μ-m)
<b>Diaphragm Material Options</b>	Hytrel, FDA Santoprene, 2-Piece PTFE, IP Bonded PTFE	Hytrel, FDA Santoprene, 2-Piece PTFE, IP Bonded PTFE	Hytrel, FDA Santoprene, 2-Piece PTFE, IP Bonded PTFE	Hytrel, FDA Santoprene, 2-Piece PTFE, IP Bonded PTFE	Hytrel, FDA Santoprene, 2-Piece PTFE, IP Bonded PTFE
<b>Shipping Weight</b>	17 lbs (7.7 kg)	36 lbs (16.3 kg)	57 lbs (25.9 kg)	106 lbs (48.1 kg)	189-239 lbs (86-108.7 kg)
<b>Height</b>	10.41" (264.41 mm)	14.44" (366.8 mm)	17.33" (440.2 mm)	26.22" (666 mm)	32.01" (813 mm)
<b>Width</b>	8.20" (208.3 mm)	10.72" (272.4 mm)	16.66" (423.2 mm)	17.18" (436.3 mm)	21.54" (547 mm)
<b>Depth</b>	8.19" (208.1 mm)	8.13" (206.4 mm)	13.66" (345.0 mm)	13.62" (346 mm)	16.96" (430.7 mm)
<b>Base to Suction</b>	0.98" (25 mm)	1.56" (39.6 mm)	2.56" (65.0 mm)	1.72" (43.6 mm)	2.31" (58.7 mm)
<b>Base to Discharge</b>	9.42" (239.3 mm)	13.63" (346.2 mm)	17.33" (440.2 mm)	24.72" (627.9 mm)	29.76" (755.9 mm)

**SPECIFICATIONS**

SS-Stainless Steel, AL-NP-Nickle Plated Aluminum, PP-Polypropylene,  
See service manual for complete specifications-  
\*Standard Configuration

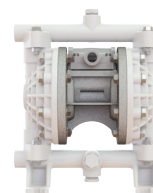
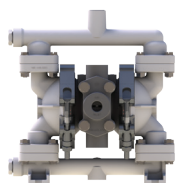
# BOLTED PLASTIC

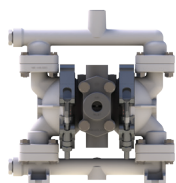

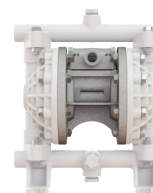
			
	<b>1/4" (6.4 MM)</b>	<b>3/8" (9.52 MM)</b>	<b>1/2" (12.7 MM)</b>
<b>PORT SIZE</b>	<b>1/4" (6.4 MM)</b>	<b>3/8" (9.52 MM)</b>	<b>1/2" (12.7 MM)</b>
<b>Pump Model</b>	E6	E8	E5
<b>Wetted Material Option</b>	PP / PVDF / ACETAL	PP / PVDF	PP / PVDF
<b>Air Side material</b>	PP / ACETAL	PP	PP
<b>Max Flow Rate Per Minute</b>	5 gpm (19.0 lpm)	6.8 gpm (25.7 lpm)	11 gpm (41 lpm)
<b>Porting Configurations</b>	Suction: Center Horz* or Side Discharge: Center Vert* or Side	Suction: Center Horz* Discharge: Center Vert	Suction & Discharge: Side* or Center Vert or Horz
<b>Connection Type</b>	1/4" FNPT Internal 1/2 MNPT External	3/8" NPT	1/2" NPT
<b>Maximum Dry Suction Lift</b>	8' (2.44 m)	8' (2.44 m)	12' (3.6 m)
<b>Air Inlet: Port Air Exhaust: Port</b>	Inlet: 1/4" NPT Exhaust: 1/4" NPT	Inlet: 1/4" NPT Exhaust: 1/4" NPT	Inlet: 3/8" NPT Exhaust: 3/8" NPT
<b>Max Solids Handling</b>	0.031" (1 mm)	0.10" (2.54 mm)	0.063" (1.6 mm)
<b>Max. Displacement per stroke</b>	0.01 gal (0.04 L)	0.009 gal (0.034 L)	0.022 gal (0.08 L)
<b>Maximum Air Inlet Pressure</b>	100 psi (6.8 bar)	100 psi (6.8 bar)	100 psi (6.8 bar)
<b>Shipping weight</b>	3.3-3.9 lbs (1.5-1.8 kg)	3.0-4.5 lbs (1.4-2.0 kg)	8.5-12 lbs (3.9-5.4 kg)
<b>Height</b>	7.90" (201 mm)	5.32" (135 mm)	11.70" (297.1 mm)
<b>Width</b>	7.52" (191 mm)	4.09" (104 mm)	9.30" (236.3 mm)
<b>Depth</b>	5.49" (139 mm)	PP: 5.72" (145 mm) PVDF: 5.67" (144 mm)	6.25" (158.8 mm)
<b>Base to Suction</b>	0.79" (20 mm)	0.94" (24 mm)	2.03" (51.5 mm)
<b>Base to Discharge</b>	7.90" (201 mm)	5.32" (135 mm)	10.06" (255.5 mm)

SPECIFICATIONS

PP-Polypropylene, PVDF-Polyvinylidene Fluoride, COND PP-Conductive Polypropylene

See service manual for complete specifications

\*Standard Configuration



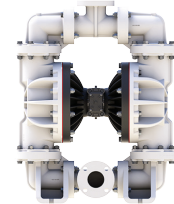
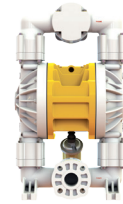
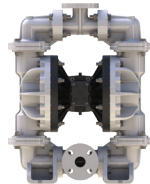
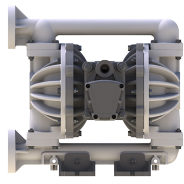

1" (25.4 MM)	1.5" (38 MM)	2" (50.8 MM)	3" (76.2 MM)
Valor	E40	U2	E3
PP / PVDF / COND PP	PP / PVDF / COND PP	PP / PVDF	PP / PVDF
PP	PP / COND PP	PP	PP
63 gpm (238 lpm)	100 gpm (378 lpm)	192 gpm (727 lpm)	280 gpm (1060 lpm)
Suction: Side* or Center Discharge: Side* or Center	Suction: Center Horz* or Vert Discharge: Center Vert* or Horz	Suction: Side* or Center Discharge: Side* or Center	Suction: Center Horz* or Vert Discharge: Center Vert* or Horz
1" 150# ANSI/DIN 325 Flange	1 1/2" ANSI / DIN Flange	2" ANSI 150# / DIN #50 Flange	3" ANSI 150# / DIN #80 Flange
19' (5.8 m)	19' (5.8m)	20' (6.1 m)	20' (6.1 m)
Inlet: 3/8" NPT Exhaust: 1/2" NPT	Inlet: 3/4" NPT Exhaust: 1" NPT	Inlet: 1/2" NPT Exhaust: 3/4" NPT	Inlet: 3/4" NPT Exhaust: 1" NPT
0.25" (6 mm)	0.47" (12 mm)	0.25" (6.4 mm)	0.71" (18.0 mm)
0.22 gal (0.83 L)	0.43 gal (1.63 L)	0.50 gal (1.90 L)	1.0 gal (3.8 L)
125 psi (6.8 bar)	100 psi (6.8 bar)	100 psi (6.8 bar)	100 psi (6.8 bar)
25-42 lbs (11.3-19 kg)	82-112 lbs (37-51 kg)	67-93 lbs (30-42 kg)	208-271 lbs (94-123 kg)
17.02" (432 mm)	28.75" (730 mm)	30.25" (768 mm)	40.66" (1033 mm)
17.42" (442 mm)	23.0" (584 mm)	19.88" (505 mm)	32.31" (821 mm)
12.25" (311 mm)	13.0" (330 mm)	12.56" (319 mm)	16.19" (411 mm)
2.50" (64 mm)	3.5" (89 mm)	3.00" (76 mm)	4.85" (123 mm)
14.83" (377 mm)	28.75" (730 mm)	27.25" (692 mm)	40.66" (1033 mm)

# SPECIALTY

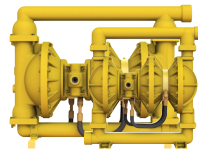
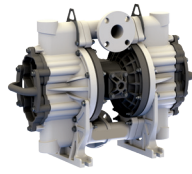

	<b>ROCKSTAR</b>	<b>2:1 HIGH-PRESSURE FULL FLOW</b>	<b>SLUDGEMASTER PNEUMATIC SUBMERSIBLE</b>	<b>PORTAPUMP 12-VOLT SUBMERSIBLE</b>
<b>Product Description</b>	The 2" (50.8mm) plastic flap valve pump was designed to offer superior solids handling up to 1.8" (46mm) in a chemically resistant light weight design. These attributes make it perfect for chemical sump, utility and mine dewatering applications.	When higher discharge pressures above 125 psi (8.6 bar) are required, turn to our high-pressure diaphragm pumps. They offer one of the widest ranges of sizes, flow rates, and materials options of any AODD pump in its category. Its full-flow design delivers smoother and greater flow rates to create pressures of up to 232 PSI (16 Bar).	When your situation calls for fast dewatering, the SludgeMaster delivers. It provides high flow rates safely. It handle solids with ease and can be coupled with our pneumatic liquid level control to create a simple, hassle free, all pneumatic sump pumping system.	The centrifugal PortaPump is rugged, submersible and conveniently operates using any common 12-volt vehicle battery. Fits through openings as small as 10" (25 cm). Ideal for pumping out ditches and manholes.
<b>Primary Applications</b>	* Chemical Sump transfer * Chemical transfer (containing solids) * Mine dewatering	* Filter press feed * Sludge transfer * High-pressure discharge	* Sump / Pit dewatering * Mine dewater	* Localized dewatering - Man holes, ditches, graves sites, golf course bunkers
<b>Industries</b>	* Chemical * General Industrial * Mining	* Chemical * Industrial Waste Treatment * Mining	* Mining * Steel Mills * Construction * Marine	* Construction * Plumbing * Municipalities and Utilities * Landscaping and Irrigation * Golf Course
<b>Key Features</b>	* Top Suction / Bottom discharge * Easy access flap checks * Light weight and portable * Flanged or threaded fluid connections	* Weighted valve balls available * Stainless steel air valve standard * PTFE seals Available * Full flow design	* Light weight 59 lbs. (26.67 kg) / Portable * Small size * High Flow rates	* Waterproof stitch * Rock screen * Lightweight 33 lbs. (15 kg) * 30' Cable with clips or two-pole connectors (-AAP).
<b>Wetted Materials Options</b>	Polypropylene	Aluminum or Stainless Steel	Aluminum w/ Cast Iron Impeller	Aluminum w/ Cast Iron Impeller
<b>Performance</b>	Max. Flow: 150 GPM (568 lpm)	Max. Flow: 1" (25mm) 33 GPM (125 lpm) / 2" (51mm) 90 GPM (341 lpm)	Max. Flow: 300 GPM (1,135.6 lpm)	Max. Flow: 43 GPM (162.8 lpm)
<b>Available Sizes</b>	2" (51.8mm)	1" (25.4 mm) and 2" (50.8 mm)	3" (76.2 mm)	1 1/2" (38 mm)
<b>Maximum Fluid Discharge Pressure</b>	100 PSI (7. Bar)	232 PSI (16 Bar)	28 PSI (2 Bar)	25' (7.6 m)
<b>Certifications</b>	CE, ABS	CE, ATEX	CE, ATEX	CE

SPECIFICATIONS

# AODD PUMP PARTS AND ACCESSORIES TO KEEP YOU PUMPING

Versamatic offers genuine parts and accessories to enhance the performance and improve the longevity of our air-operated double-diaphragm (AODD) pumps. From convenient service kits to accessories that boost performance, our genuine parts are tailor-made for your Versamatic AODD pump.

**DIAPHRAGMS**



**SURGE SUPPRESSORS**



**AIR FILTER REGULATOR**



**LIQUID LEVEL CONTROLLER**

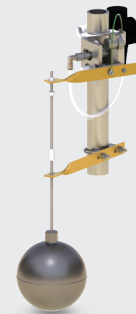

Visit us online to learn more about our line of accessories. Be sure to check out the video library for quick tips, installation, and repair videos.

## DIAPHRAGM PUMP SERVICE KITS – KEEP YOUR PUMP RUNNING

### COMPLETE PUMP REPAIR KITS – KEEP YOUR PUMP RUNNING LONGER

Our repair kits are comprised of only the necessary components to ensure a complete pump repair. These kits reduce costly downtime, lost production and multiple maintenance associated with partial repairs.

#### REPAIR KITS

##### Wet End Repair Kit:

- Diaphragms
- Balls
- Seats

##### Air End Repair Kit:

- Seals
- O-rings
- Gaskets
- Retaining Rings
- Pilot Valve Assembly
- Lubricant
- Assembly Lubricant

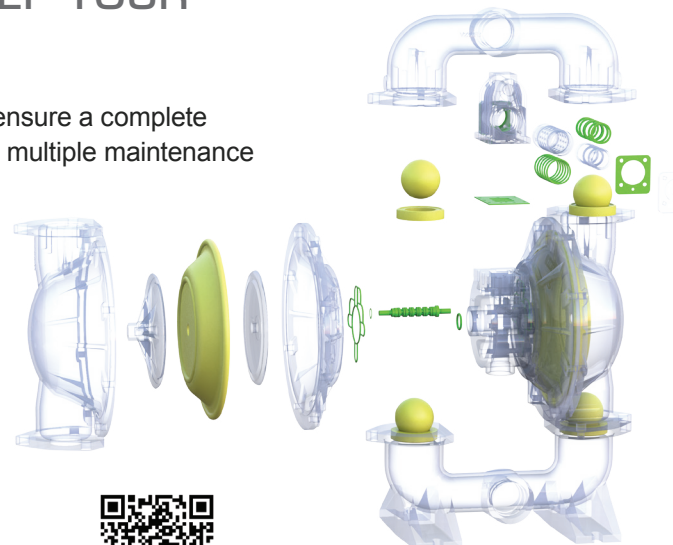

VERSAMATIC.COM



# RESOURCES AVAILABLE

## LITERATURE



## CHEM GUIDE



## BLOGS



## PUMP SELECTOR



## CERTIFICATIONS



## VIDEOS



## ALL RESOURCES

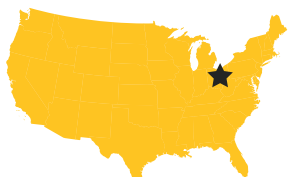

Designed and assembled in the USA

©Copyright 2024 Warren Rupp, Inc. All Rights Reserved  
VM\_CAT\_ProductCatalog\_0224



800 North Main Street  
Mansfield, OH 44902

419-526-7296

versamatic.com

